

LX 14/50 TRIPLEX FREE LIFT

DESIGNED FOR TOP PERFORMANCE



The LX II edition is a strong and reliable partner which bridges the gap between low-duty and heavy duty material handling daily operations. Due to its durability, low maintenance LX is suitable for environments as logistic centers, terminals, production and manufacturing areas. Also the new tiller arm equipped with fork lifting and lowering proportional control improves user-friendliness and maneuverability of the truck.

TRIPLEX FREELIFT

The combination of the three lifting stages with two lateral cylinder of the Triplex and a central lifting cylinder allow a full freelif (h2): lifting fork without increasing the minimum overall stacker size (h1) to work in container and low roof warehouses



ZAPI CONTROLLER

AC technology guarantees more energy efficiency and longer battery charging duration, thus reducing maintenance cost. Furthermore the absence of brushes in the motor, the simpler motor structure and the possibility of adjusting parameters increase system reliability.



TILLER EVOLUTION

Fully integrated ergonomic technopolymer tiller system including finger tip throttle and proportional fork controls, safety pushbutton, horn, turtle button, hourmeter, battery status indicator as standard equipment.



MANEUVERABILITY

The overall width has the same size than the EuroPallet (800mm) allow the unit to work in narrow spaces and corridors, increase maneuverability and reducing the turning radius.



VISIBILITY

The wide mast and central driving position allow to have a great operator visibility



BATTERY COMPARTMENT

The separate battery compartment allows the installation of high capacity battery (225Ah - 300Ah). The battery inspection is easy and comfortable through the battery cover with hinges. As option automatic battery refilling system can be supplied as the external high frequency battery charger that can be easily plugged through Anderson connector.



EASY MAINTENANCE

Removing the strong cover allow to have the access to electric and hydraulic system as to the motorwheel and stabilizing wheels.



OPERATOR PLATFORM

The LX stacker can be equipped with cushioned stand-on foldable platform very useful for covering medium-sized distances and for intensive application.



Description

1.1 Manufacturer			PR INDUSTRIAL
1.3 Drive			Electric
1.4 Operator type			Pedestrian
1.5 Load capacity	Q	kg	1400
1.6 Load centre distance	c	mm	600
1.8 Load axle to end forks	x	mm	797
1.9 Wheel base	y	mm	1436

Weights

2.1 Service weight (battery included)		kg	1262
2.1 Service weight, With platform - battery included		kg	1302
2.2 Axle load, laden rear		kg	1727
2.2 Axle load, laden front		kg	935
2.3 Axle load, unladen front		kg	849
2.3 Axle load, unladen rear		kg	413

Tyres/Chassis

3.1 Tyres: front wheels			RUBBER
3.1 Tyres: stabilizers wheels - front			POLY.C.
3.1 Tyres: rear wheels			POLY.C.
3.2 Tyre size: Steering wheels - Width		mm	101
3.2 Tyre size: Steering wheels - Diameter		mm	250
3.3 Tyre size: Load rollers - Diameter		mm	82
3.3 Tyre size: Load rollers - Width		mm	70
3.4 Tyre size: stabilizers wheels front - Diameter		mm	100
3.4 Tyre size: stabilizers wheels front - Width		mm	38
3.5 Tyre size: rear wheels - Q.ty (X=driven)		nr	4
3.5 Tyre size: front wheels - Q.ty (X=driven)		nr	1x
3.6 Tread, front	b10	mm	586
3.7 Tread, rear	b11	mm	390

Dimensions

4.2 Height, mast lowered	h1 mm	2294
4.3 Normal free lifting	h2 mm	1675
4.4 Lift height	h3 mm	5025
4.5 Height, mast extended	h4 mm	5644
4.9 Height of tiller in drive position min	h14 mm	990
4.9 Height of tiller in drive position max	h14 mm	1390
4.15 Height, lowered	h13 mm	90
4.19 Overall length	l1 mm	1966
4.19 Overall length with lowered platform	l1 mm	2550
4.19 Overall length with raised platform	l1 mm	2090
4.20 Length to face of forks	l2 mm	816
4.20 Length to face of forks with lowered platform	l2 mm	1400
4.20 Length to face of forks with raised platform	l2 mm	940
4.21 Overall width	b1/ b2 mm	800
4.22 Fork dimensions - Thickness	s mm	70
4.22 Fork dimensions - Width	e mm	170
4.22 Fork dimensions - Length	l mm	1150
4.24 Fork carriage width	b3 mm	644
4.25 Distance between fork arms	b5 mm	560
4.32 Ground clearance, centre of wheelbase	m2 mm	20
4.34 Aisle width	Ast mm	2380
4.34 Aisle width with lowered platform	Ast mm	2964
4.34 Aisle width with raised platform	Ast mm	2510
4.35 Turning radius	Wa mm	1613
4.35 Turning radius with lowered platform	Wa mm	2196
4.35 Turning radius with raised platform	Wa mm	1742

Performance data

5.1 Travel speed laden	km/h	6.0
5.1 Travel speed unladen	km/h	6.0
5.1 Travel Speed Laden with platform in lowered position	km/h	6.0
5.1 Travel speed unladen with platform in lowered position	km/h	6.0
5.1 Travel speed laden with platform in raised position or with raised forks	km/h	6.0
5.1 Travel speed unladen with platform in raised position or with raised forks	km/h	6.0
5.2 Lifting speed laden	m/s	0.14
5.2 Lifting speed unladen	m/s	0.28
5.3 Lowering speed laden	m/s	0.34
5.3 Lowering speed unladen	m/s	0.40
5.8 Max gradeability laden	%	5
5.8 Max gradeability unladen	%	10
5.10 Service brake		REVERSE CURRENT BRAKING

Electric motors

6.1 Drive motor power	kW	1.2
6.2 Lift motor power	kW	3.2
Battery Type	Type	Traction (C5)
6.4 Battery voltage	V	24
6.4 Battery capacity, Min	Ah	225
6.4 Battery capacity, Max	Ah	300
6.5 Battery weight, Min	kg	270
6.5 Battery weight, Max	kg	270
6.6 Energy consumption according to VDI cycle	kWh/h	1.17
8.4 Sound level at driver's ear	dB(A)	67

Residual lifting capacity

Lifting height (H3) 3300 mm	Kg	1400
Lifting height (H3) 3600 mm	Kg	1200
Lifting height (H3) 4000 mm	Kg	1000
Lifting height (H3) 5000 mm	Kg	800

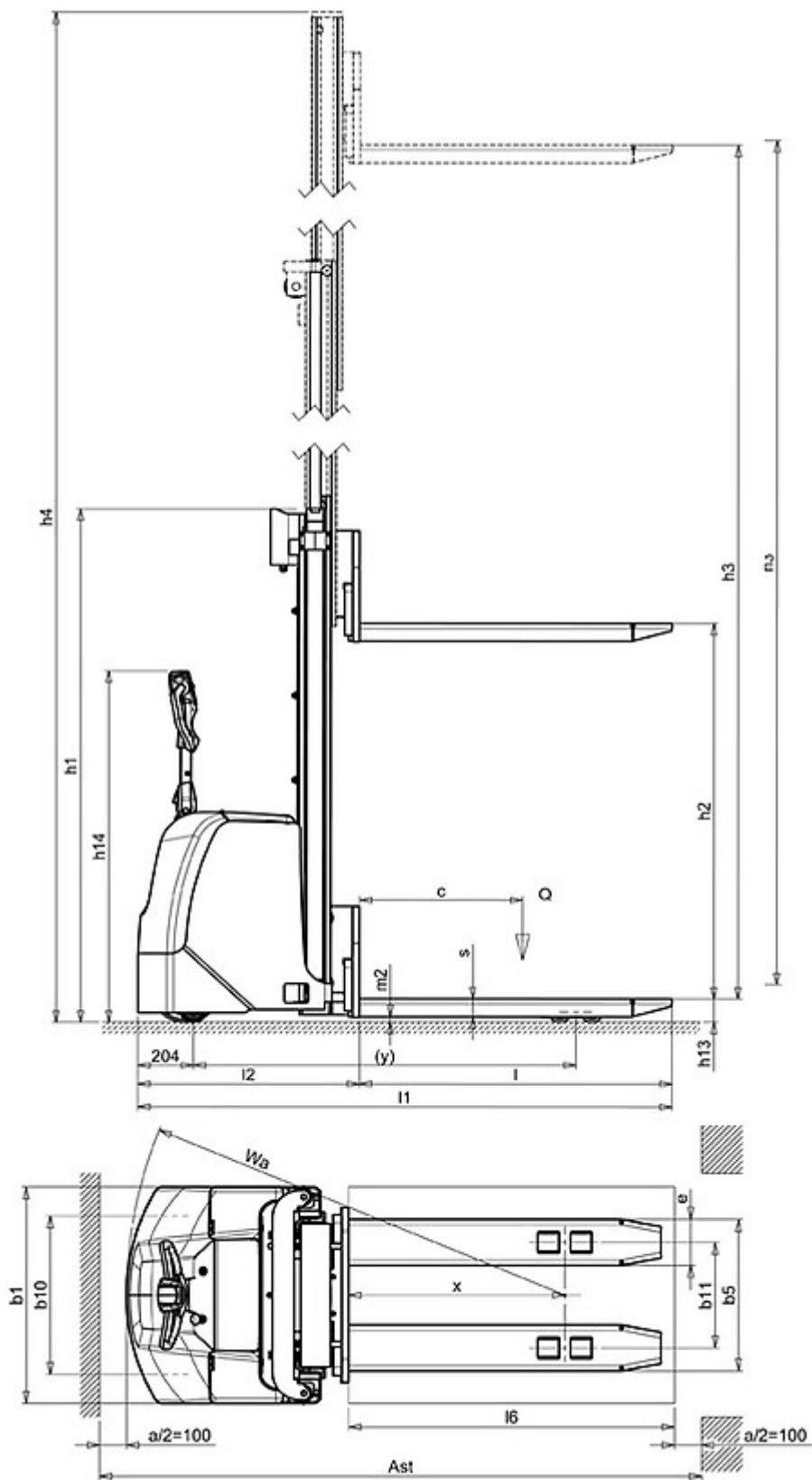

The information is aligned with the Data file at the time of download. Printed on 11/07/2022 (ID 3107)

©2022 | PR INDUSTRIAL s.r.l. | All rights reserved | Image shown may not reflect actual package. Specifications subject to change without notice